

Aufstellvorrichtungen

Alle Rohrpfosten werden mit Kunststoffkappe und Rundeisen-Erdanker geliefert.

Rohrpfosten aus Stahl verzinkt

Rohrpfosten Stahl verzinkt Länge (mm)	Wandstärke 2,0 mm ø 60 mm		Wandstärke 2,9 mm ø 60 mm		Wandstärke 2,0 mm ø 76 mm		Wandstärke 2,9 mm ø 76 mm	
	Art-Nr.	Preis	Art-Nr.	Preis	Art-Nr.	Preis	Art-Nr.	Preis
1500	P1500 S115	23,55	PS1500 S215	44,00	P1500-76 S315	41,80	PS1500-76 S415	59,40
1750	P1750 S117	29,15	PS1750 S217	49,50	P1750-76 S317	46,20	PS1750-76 S417	63,80
2000	P1 S120	31,35	PS1 S220	52,80	P1-76 S320	49,50	PS1-76 S420	68,20
2250	P2 S122	35,75	PS2 S222	58,30	P2-76 S322	51,70	PS2-76 S422	72,60
2500	P3 S125	40,70	PS3 S225	62,70	P13 S325	55,00	PS3-76 S425	77,00
2750	P4 S127	45,10	PS4 S227	68,20	P14 S327	60,50	PS4-76 S427	81,40
3000	P5 S130	49,50	PS5 S230	71,50	P15 S330	66,00	PS15 S430	85,40
3250	P6 S132	53,90	PS6 S232	77,00	P16 S332	71,50	PS16 S432	92,40
3500	P7 S135	58,30	PS7 S235	82,50	P17 S335	77,00	PS17 S435	99,00
3750	P8 S137	62,70	PS8 S237	88,00	P18 S337	82,50	PS18 S437	105,60
4000	P9 S140	67,10	PS9 S240	93,50	P19 S340	88,00	PS19 S440	112,20
4250	P10 S142	75,90	PS10 S242	104,50	P20 S342	102,30	PS20 S442	123,20
4500	P11 S145	85,90	PS11 S245	115,50	P21 S345	108,90	PS21 S445	136,40
4750	P12 S147	95,70	PS12 S247	126,50	P22 S347	121,00	PS22 S447	143,00
5000	P23 S150	105,60	PS13 S250	143,00	P24 S350	136,40	PS23 S450	162,80

Weitere Rohrpfosten lieferbar,

z.B. Rohrpfosten mit Fußplatte und Rohrpfosten mit anderem Durchmesser.



Die Pfostenlängen und Rohrabmessungen sind auf die in der VwV-StVO festgelegten Bodenfreiheiten abgestellt.

Diese sind: bei Hochaufstellung	2,00 m
über Radwegen	2,20 m
bei Tiefaufstellung	1,00 m
auf Inseln und Verkehrsteilern	0,60 m

Rohrpfosten aus Aluminium

Rohrpfosten Aluminium Länge (mm)	Wandstärke 2,5 mm ø 60 mm		Wandstärke 3,0 mm ø 76 mm	
	Art-Nr.	Preis	Art-Nr.	Preis
1500	AP1500 A215	36,00	APS1500 A415	58,00
1750	AP1750 A217	40,00	APS1750 A417	63,00
2000	AP1 A220	44,00	APS11 A420	68,00
2250	AP2 A222	49,00	APS12 A422	73,00
2500	AP3 A225	54,00	APS13 A425	78,00
2750	AP4 A227	59,00	APS14 A427	83,00
3000	AP5 A230	64,00	APS15 A430	90,00
3250	AP6 A232	69,00	APS16 A432	97,00
3500	AP7 A235	74,00	APS17 A435	104,00
3750	AP8 A237	79,00	APS18 A437	111,00
4000	AP9 A240	84,00	APS19 A440	118,00
4250	AP10 A242	94,00	APS20 A442	130,00
4500	AP11 A245	104,00	APS21 A445	142,00
4750	AP12 A247	114,00	APS22 A447	154,00
5000	AP13 A250	134,00	APS23 A450	176,00

Bitte berücksichtigen Sie bei der Ermittlung der Pfostenlängen die Schildhöhe, die gewünschte Bodenfreiheit, evtl. Längenänderungen, die aus örtlichen Gegebenheiten resultieren und die Einbinde-tiefe in den Boden (500 – 700 mm). Über Rad- und Fußwegen sollte die Bodenfreiheit entsprechend der RAL-Q 2,25 m (2250 mm) betragen.

Beispiel einer Pfostenlängenbestimmung

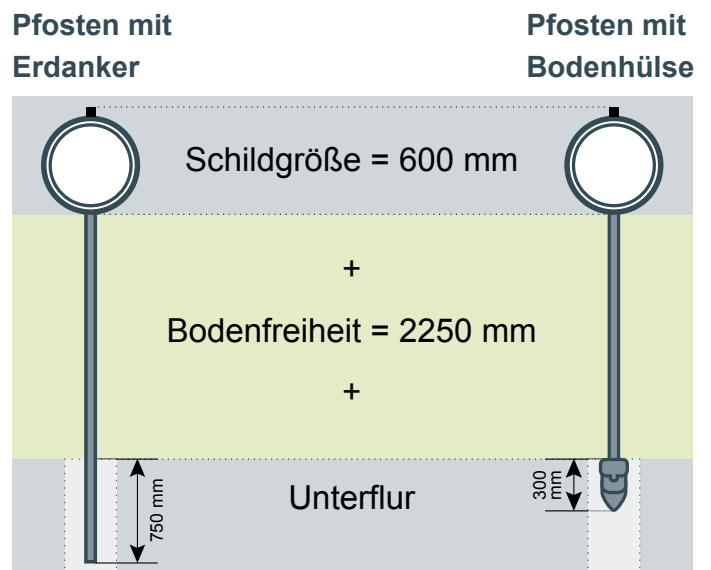

Abmessungen Standard-Flachverkehrszeichen:

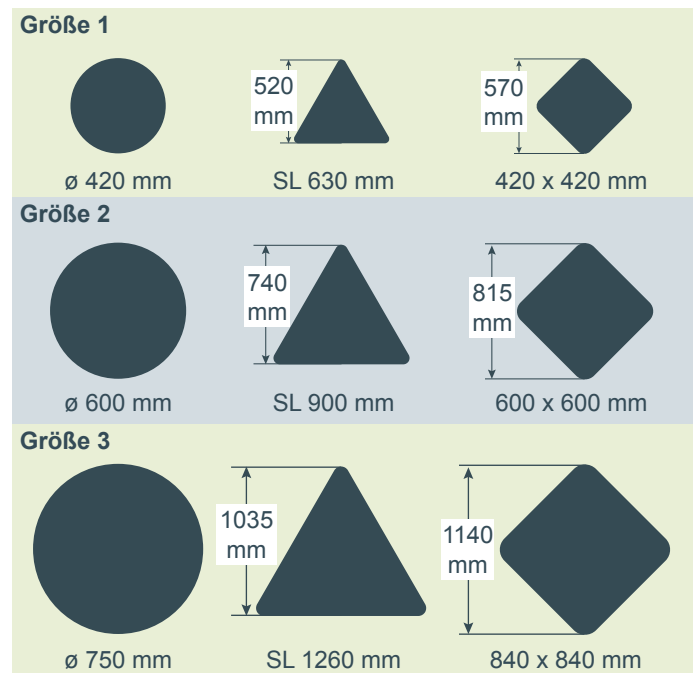

Bodenhülsen Stahl verzinkt, mit Feststellvorrichtung.

Bodenhülse Stahl verzinkt	∅ 60 mm		∅ 76 mm	
	Art-Nr.	Preis	Art-Nr.	Preis
Länge 300 mm	BH 3	61,50	—	—
Länge 500 mm	BH 5	66,50	BH 5a	82,00

Zubehör

Zubehör Bodenhülse Stahl verzinkt	∅ 60 mm		∅ 76 mm	
	Art-Nr.	Preis	Art-Nr.	Preis
Abdeckstopfen	BH A 60	14,00	BH A 76	15,00
Ersatzinbussschlüssel für beide Größen			EIS	3,80

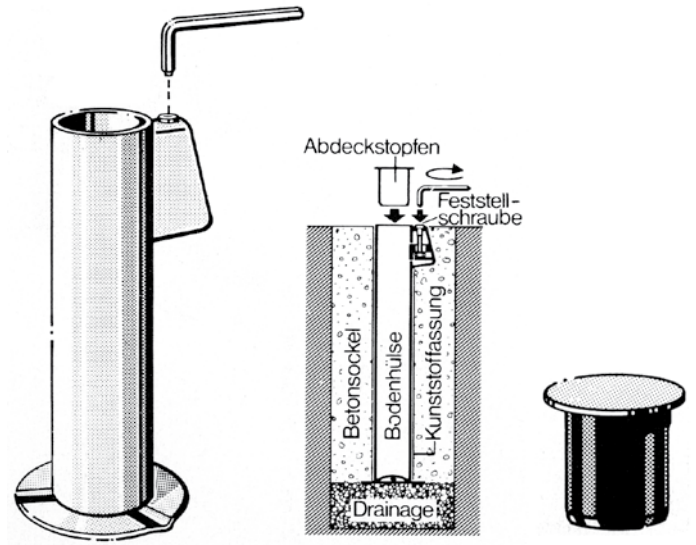

Bodenhülsen aus Grauguss GG20 mit Gewinding und Nylon-Klemmring

Bodenhülse GG20 Grauguss Schlüsselweite	∅ 48 mm SW 65 mm		∅ 60 mm SW 85 mm		∅ 76 mm SW 95 mm	
	Art-Nr.	Preis	Art-Nr.	Preis	Art-Nr.	Preis
Länge 300 mm	BH 48/65	41,00	BH 60/85	45,00	BH 76/95	61,00
Länge 500 mm	—	—	BH 60/85-500	75,00	BH 76/95-500	85,00

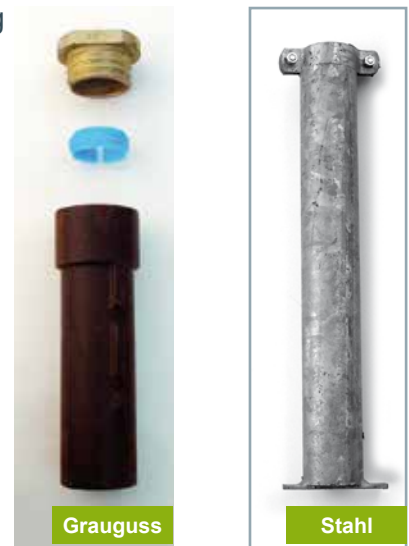

Bodenhülsen Stahl verzinkt, mit angeschweißter Halbschelle

Bodenhülse Stahl verzinkt	∅ 48 mm		∅ 60 mm		∅ 76 mm	
	Art-Nr.	Preis	Art-Nr.	Preis	Art-Nr.	Preis
Länge 600 mm	Auf Anfrage	—	BH 60	42,50	BH 76	55,00

Zubehör für Graugussbodenhülsen

Zubehör und Er- satzteile zu GG20	∅ 48 mm		∅ 60 mm		∅ 76 mm	
	Art-Nr.	Preis	Art-Nr.	Preis	Art-Nr.	Preis
Blindstopfen	BST 48	10,00	BST 60	11,80	BST 76	13,50
Gewinding	GEW 48	9,80	GEW 60	11,00	GEW 76	12,50
Klemmring Nylon	KLN 48	2,50	KLN 60	2,20	KLN 76	2,50
Gabelschlüssel	GS 48	135,00	GS 60	135,00	GS 76	135,00
Kombi-Gabelschlüssel	sowohl für ∅ 60 als auch ∅ 76				GS-Kombi	135,00





Fertigfundament

Fertigfundament Art-Nr.	ø (mm)	Preis
A/60	60	95,00
A/76	76	120,00

Abmessungen

Höhe: ca. 600 mm
 konisch zulaufend
 Oben: ca. 180 x 180 mm
 Unten: ca. 250 x 250 mm
 Gewicht: ca. 60 kg

Betonsockelstein mit je 4 Hartholzkeilen

Betonsockelstein	Art-Nr.	ø (mm)	Höhe (mm)	Gewicht (kg)	Preis
	B/60-450	60	450	33	36,80
	B/60-600	60	600	41	41,75
gemäß IVZ Typ A	B/60-750	60	750	152	165,50
	B/76-700	76	700	68	61,40
gemäß IVZ Typ B	B/76-850	76	850	172	173,90



Abmessungen

B/60 konisch:
 Oben: ca. 170 x 170 mm
 Unten: ca. 200 x 200 mm
 B/76 zylindrisch:
 220 x 220 mm
 IVZ Typ A und IVZ Typ B:
 300 x 300 mm

Rohrkappen für Rohrfosten

Rohrkappen aus witterungsbeständigem Kunststoff, schwarz	Art-Nr.	ø (mm)	Preis
	RK 60	60	1,60
	RK 76	76	1,80



Gras-Stopp-Platten für Rundrohre

Gras-Stopp-Platten	Art-Nr.	für Pfosten ø (mm)	Preis
	GSR 42	42	12,40
	GSR 48	48	12,40
	GSR 60	60	12,40
	GSR 76	76	12,40



Aus witterungsbeständigem Kunststoff, hindern den Bewuchs und verbessern so die Sichtbarkeit.



Steighilfe



Steighilfe

Steighilfe

Steighilfe Art-Nr.	ø (mm)	Preis
Steighilfe-60	60	481,00
Steighilfe-76	76	531,00

Rohrverlängerungen (Longfix)

Rohrverbindungselemente aus Stahl (verzinkt), verwendbar für Stahl- und Aluminium-Rohrpfosten.

Lieferbar in 8 verschiedenen Ausführungen:

- für Rohrpfosten Ø 60 mit Wandstärke 2 mm
- für Rohrpfosten Ø 60 mit Wandstärke 3 mm
- für Rohrpfosten Ø 76 mit Wandstärke 2 mm
- für Rohrpfosten Ø 76 mit Wandstärke 3 mm

Wichtig: Bitte überprüfen Sie die Wandstärke der von Ihnen verwendeten Rohrpfosten!

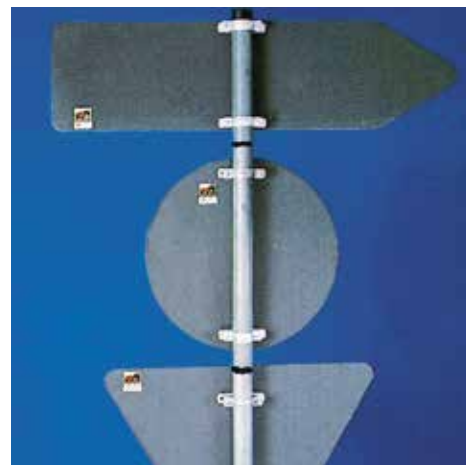

Verlängerung im oberen Pfostenbereich

Longfix Art-Nr.	Normallänge 160 mm (DBP) Rohrpfosten ø (mm)	Preis pro Stück
LF 60/2 -160	60 x 2	29,50
LF 60/3 -160	60 x 3	32,40
LF 76/2 -160	76 x 2	39,00
LF 76/3 -160	76 x 3	40,50

Pfostenreparatur im Bodenbereich

Longfix Art-Nr.	Sonderlänge 300 mm (DBP) Rohrpfosten ø (mm)	Preis pro Stück
LF 60/2 -300	60 x 2	40,00
LF 60/3 -300	60 x 3	42,40
LF 76/2 -300	76 x 2	46,00
LF 76/3 -300	76 x 3	48,60

Art-Nr.	Einschlaghülsen für Rohrpfosten ø (mm)	Preis pro Stück
EH 60	60	102,60
EH 76	76	121,50

Rohrclip für Pfosten ø (mm)	Art-Nr.	ø (mm)	Preis
	Rohrclip 60	60	98,60
	Rohrclip 76	76	132,60

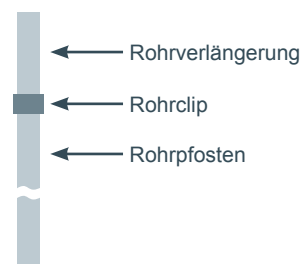

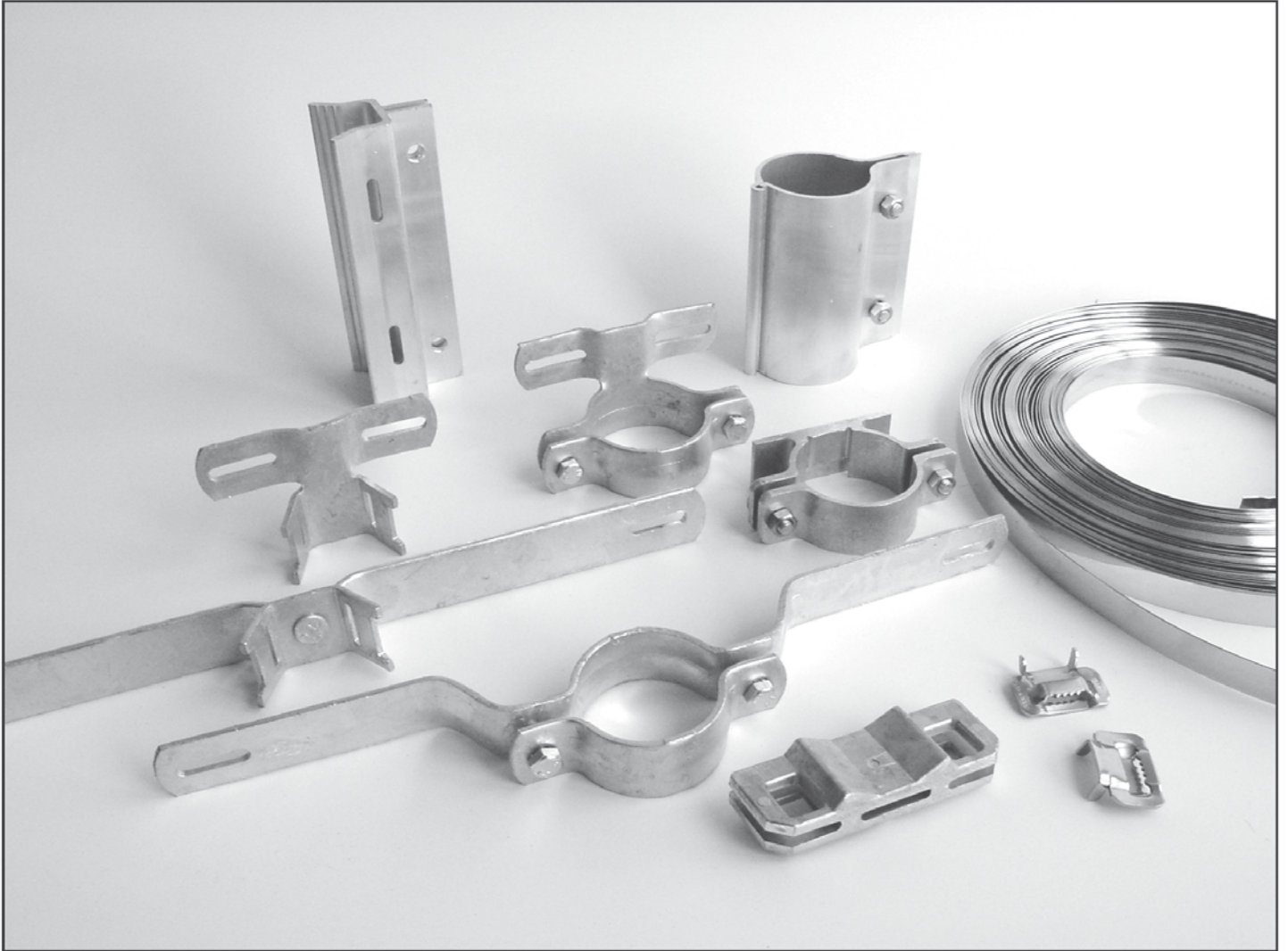

Befestigungs-Schellen für profilverstärkte Schilder inkl. Schrauben aus V2A

Klemmschelle Aluminium	Art-Nr.	∅ (mm)	Preis
	LS 60	60	8,00
	LS 76	76	9,50

Doppelklemmschelle	Art-Nr.	∅ (mm)	Preis
	LDS 60	60	10,50
	LDS 76	76	11,50

Alform-Klemmschelle Aluminium	Art-Nr.	∅ (mm)	Preis
	AKS 48	48	7,90
	AKS 60	60	8,20
	AKS 76	76	9,30

Doppel-Alform-Klemmschelle	Art-Nr.	∅ (mm)	Preis
	AKS D 48	48	10,50
	AKS D 60	60	10,90
	AKS D 76	76	12,60

Einfachschelle Edelstahl	Art-Nr.	∅	Preis
	EKS 60	60	8,85
	EKS 76	76	9,80

Doppelschelle Edelstahl	Art-Nr.	∅	Preis
	DEKS 60	60	13,50
	DEKS 76	76	16,25

Bandschelle Edelstahl	Art-Nr.	Preis
	BEKS	7,10

Alform-Bandschelle	Art-Nr.	Preis
	AB	11,00

Stahlband siehe Seite 79.

Alform-Flachtraversen

aus feuerverzinktem Flachstahl, 45 x 6 mm, mit 120 mm langen Alu-Klemmprofilen und Befestigungsmaterial aus V2A

Flachtraverse feuerverzinkt ∅ (mm)	400 mm Steglänge mit 2 Klemmklötzen		800 mm Steglänge mit 4 Klemmklötzen	
	Art-Nr.	Preis	Art-Nr.	Preis
60	AFL 60/4	35,00	AFL 60/8	55,00
76	AFL 76/4	40,00	AFL 76/8	60,00
88,9	AFL 88,9/4	45,00	AFL 88,9/8	65,00
108	AFL 108/4	50,00	AFL 108/8	70,00
133	AFL 133/4	55,00	AFL 133/8	75,00
152	AFL 152/4	60,00	AFL 152/8	80,00
Band	AFL B/4	32,00	AFL B/8	54,00

Alform-Bandschelle	Art-Nr.	Preis
	AKB	6,60

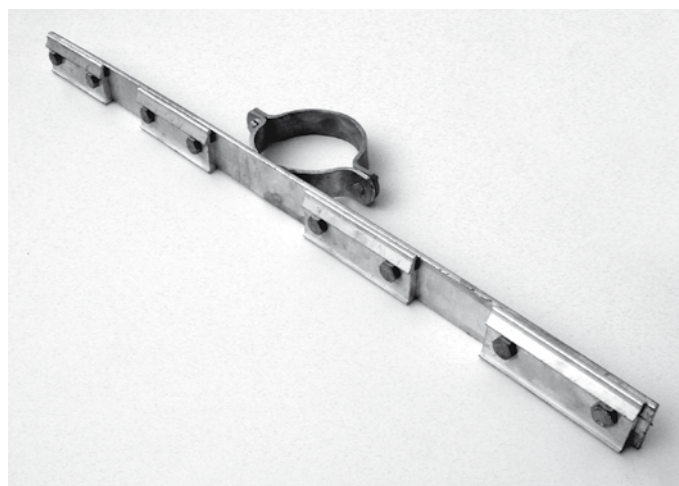

Rohrschellen, feuerverzinkt,
für gelochte Verkehrszeichen
inkl. verzinkter Schrauben M8x25



R 0, R 1, R 11



R 2 - R 5, R 12 - R 15



R 21 - R 45

Rohrschellen Stahl ø (mm)	Lochabstand 70 mm		Lochabstand 350 mm		Lochabstand 500 mm		Lochabstand 700 mm		Lochabstand 900 mm	
	Art-Nr.	Preis	Art-Nr.	Preis	Art-Nr.	Preis	Art-Nr.	Preis	Art-Nr.	Preis
48	R 0	4,00	—	—	—	—	—	—	—	—
60	R 1 R 107	3,30	R 2 R 135	6,90	R 3 R 150	7,40	R 4 R 170	8,50	R 5 R 190	9,00
76	R 11 R 307	4,40	R 12 R 335	7,40	R 13 R 350	8,00	R 14 R 370	9,00	R 15 R 390	9,50
88,9	R 21 R 507	10,80	R 22 R 535	15,30	R 23 R 550	18,60	R 24 R 570	23,40	R 25 R 590	26,80
108	R 31 R 607	11,80	R 32 R 635	16,50	R 33 R 650	19,80	R 34 R 670	25,00	R 35 R 690	28,00
133	R 41 R 707	18,80	R 42 R 735	24,20	R 43 R 750	26,10	R 44 R 770	28,30	R 45 R 790	30,40

Bandbügel
für gelochte Verkehrszeichen,
Stahlband siehe Seite 79.



B 1



B 2 - B 5



BA 1



E 1

Bandbügel	Lochabstand 70 mm		Lochabstand 350 mm		Lochabstand 500 mm		Lochabstand 700 mm		Lochabstand 900 mm	
	Art-Nr.	Preis	Art-Nr.	Preis	Art-Nr.	Preis	Art-Nr.	Preis	Art-Nr.	Preis
Stahl verzinkt	B 1 B 107	3,30	B 2 B 135	5,50	B 3 B 150	6,20	B 4 B 170	7,40	B 5 B 190	9,30
Aluminium	BA 1	6,90	—	—	—	—	—	—	—	—
Edelstahl	E 1	8,20	—	—	—	—	—	—	—	—

Einarmschellen für seitliche Befestigung

Einarmschellen Stahl verzinkt	ø	Lochabstand 350 mm		Lochabstand 500 mm		Lochabstand 700 mm		Lochabstand 900 mm	
		Art-Nr.	Preis	Art-Nr.	Preis	Art-Nr.	Preis	Art-Nr.	Preis
	60 mm	ER 2 ER 135	12,00	ER 3 ER 150	13,60	ER 4 ER 170	13,60	ER 5 ER 190	16,90
	76 mm	ER 12 ER 335	13,50	ER 13 ER 350	14,90	ER 14 ER 370	16,50	ER 15 ER 390	19,20
	88,9 mm	ER 22 ER 535	20,80	ER 23 ER 550	22,90	ER 24 ER 570	23,80	ER 25 ER 590	26,70
	108 mm	ER 32 ER 635	23,20	ER 33 ER 650	24,90	ER 34 ER 670	27,10	ER 35 ER 690	28,60

Einarmbandschellen für seitliche Befestigung

Einarmbandschellen Stahl verzinkt	Lochabstand 350 mm		Lochabstand 500 mm		Lochabstand 700 mm		Lochabstand 900 mm	
	Art-Nr.	Preis	Art-Nr.	Preis	Art-Nr.	Preis	Art-Nr.	Preis
	EB 2 EB 135	17,80	EB 3 EB 150	20,00	EB 4 EB 170	22,60	EB 5 EB 190	24,60

Edelstahlband

Stahlband 30 m/Rolle Edelstahl rostfrei	Art-Nr.	Breite (mm)	Preis
	EB 1/2"	12	47,90
	EB 5/8"	16	55,40
	EB 3/4"	19	59,40

Spannschloss

Spannschloss, verzinkt	Art-Nr.	Breite (mm)	Preis
	SPS	19	6,80

Schneckschraubschellen, Edelstahl

Eine hochwertige Präzisionsschelle mit höchster Anzugsbelastbarkeit. Schwere Baureihe in Interlockbauweise, dadurch keine Korrosion durch Punktschweißen. Bandbreite 14 mm - Bandstärke 0,6 mm.

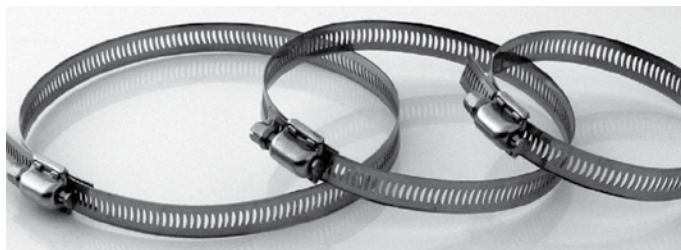

Schnecken- schraubschellen Art-Nr.	∅ Spannbereich (mm)	Länge (mm)	Preis
A 30	40 – 60	300	13,80
A 35	50 – 70	350	14,25
A 40	60 – 80	400	14,70
A 45	70 – 90	450	15,15
A 50	80 – 100	500	15,60
A 55	90 – 110	550	16,05
A 60	100 – 120	600	16,50
A 65	120 – 140	650	16,95
A 70	140 – 160	700	17,40
A 75	160 – 180	750	17,85
A 80	180 – 200	800	18,30
A 85	200 – 220	850	18,75

Schlaufe

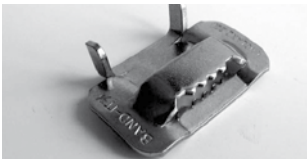
Schlaufe 100 Stück/Paket Edelstahl rostfrei	Art-Nr.	Breite (mm)	Preis
	SF 1/2"	12	31,20
	SF 5/8"	16	38,80
	SF 3/4"	19	39,60

Spannwerkzeug

Spannwerkzeug	Art-Nr.	Preis
	SWZ	153,00
Ersatzteile auf Anfrage		

1000 N Längskraft bei 3,5 Nm Drehmoment.
Endkraft vor Bruch 2500 Nm



Typ	Breite 14 mm Art-Nr.	Anzahl/Art	Preis
Schraubengehäuse	A 210	1 Stck.	3,80
Schellenband	A 213	30 m-Rolle	133,00

Anleitung für den Zusammenbau

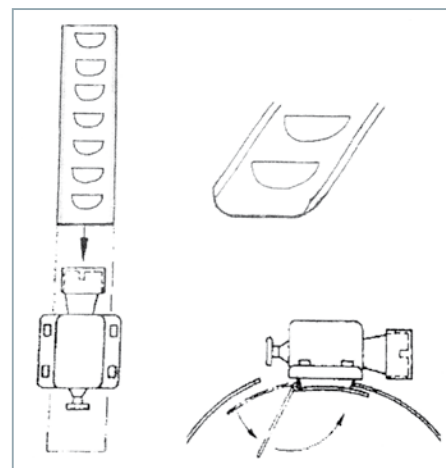

Befestigungsband Tamtorque™

Hohe Belastbarkeit und Stabilität, bis zu 1200N/mm², Materialstärke 0,8 mm, Bandbreite 16 mm. Diebstahlsicher durch einzigartiges Verschlusssystem. Die Schraube kann nur mit dem speziellen Tamtorque-Werkzeug/Bit geöffnet werden.

Mit Spezialverschluss am freien Ende des Bandes, daher keine Verletzungsgefahr.

Wiederverwendbar. Einfache Handhabung.



Befestigungsband Tamtorque™ Art-Nr.	∅ Spannbereich (mm)	Preis
TTK70P	55 – 70	10,50
TTK100P	70 – 100	11,50
TTK130P	100 – 130	12,30
TTK160P	130 – 160	13,50
TTK190P	160 – 190	14,20
TTK250P	190 – 250	15,60
TTK340P	250 – 340	18,30



Rolle Art-Nr.	Ausführung	Preis
MTB10P	10 Meter Band	126,70
MTB30P	30 Meter Band	314,90



MTTCK150P	Verbinder	13,75
-----------	-----------	-------

Werkzeug/Bits Tamtorque™



Schraubendreher	
Art-Nr.	Preis
DTT1BG	42,70



Ratsche inkl. Nuss	
Art-Nr.	Preis
DTT2BG	83,70



1/4" Nuss	
Art-Nr.	Preis
DTTB2BG	15,60



Bit (2 Stück)	
Art-Nr.	Preis
DTTBP50BG	8,00



Langer Bit	
Art-Nr.	Preis
DTTBP170BG	25,70

Eine Bedienungsanleitung finden Sie auf unserer Homepage www.adco-rhede.de

Aluminium-Schelle für gelochte Schilder	Art-Nr.	Lochabstand 70 mm	∅ (mm)	Preis
	AR 1	7er Schlitz	60	9,80
	AR 2	7er Schlitz	76	10,80
	AR 1-9	9er Schlitz	60	9,80
	AR 2-9	9er Schlitz	76	10,80

Winkelschellen

für Richtungstafeln 500 x 500 mm, aus feuerverzinktem Flachstahl 30 x 5 mm, im Winkel von 90°, inkl. Schrauben M8 x 25

Winkelschelle	Art-Nr.	∅	Preis
	WSE 60	60	15,00

Winkelschelle	Art-Nr.	∅	Preis
	WS 60	60	23,50
	WS 76	76	28,00

Fuvial –

Rohr- und Bandschelle aus Aluminium für Schilder von 2 – 4 mm.

Rohr-/Bandschelle Aluminium	∅ mm	Höhe 100 mm		Höhe 150 mm		Höhe 200 mm		Höhe 250 mm	
		Art-Nr.	Preis	Art-Nr.	Preis	Art-Nr.	Preis	Art-Nr.	Preis
Schelle	60	FR 60/1	18,50	FR 60/2	22,00	FR 60/3	26,50	FR 60/4	31,00
Schelle	76	FR 76/1	20,50	FR 76/2	26,50	FR 76/3	32,00	FR 76/4	36,50
Bandschelle	—	FB 1	16,00	FB 2	20,00	FB 3	23,50	FB 4	27,00



FR



FB

Doppelrohr-Schellen, feuerverzinkt	Art-Nr.	Ausführung	∅ (mm)	Preis
	DR 107	gegenüberliegend montiert	60	4,40
		übereinander montiert		
	R 107 D	übereinander montiert	60	6,00

Dreieck-Winkel-Schelle für Schildbreite 750 mm

Dreieck-Winkel-Schelle	Art-Nr.	∅	Preis
	DWS 60	60	65,50
	DWS 76	76	68,50



Andreaskreuzbügel, Stahl verzinkt

Art-Nr.		Preis
AKB-60	für Pfosten ø 60 mm	95,70
AKB-76	für Pfosten ø 76 mm	95,70
AKB-B	für Bandbefestigung	95,70
AKBL-60	rot lackiert, für Pfosten ø 60 mm	146,60
AKBL-76	rot lackiert, für Pfosten ø 76 mm	146,60
AKBL-B	rot lackiert, für Bandbefestigung	146,60



Schelle für Andreaskreuz, Stahl verzinkt

Art-Nr.		Preis
SAK-60	für Pfosten ø 60 mm	13,15
SAK-76	für Pfosten ø 75 mm	13,15
SAK-B	für Bandbefestigung	13,15

Schellen für Fahrbahntrenner, feuerverzinkt, inkl. verzinkter Schrauben

Schellen für FB 1	Art-Nr.	ø	Preis
	FBR1-60	60	19,50
	FBR1-76	76	22,50

Schelle für FB 3	Art-Nr.	ø	Preis
	FBR3-60	60	22,50

Schelle für FB 5	Art-Nr.	ø	Preis
	FBR5-60	60	19,50

Schild- und Schellenbefestigungen

Sechskantschrauben
Edelstahl mit Unterlegscheibe
und Mutter, 100 Stück

Art-Nr.	Typ	Preis
M6 x 16	M6 x 16	42,00
M8 x 25	M8 x 25	81,00



Schlossschrauben
Edelstahl mit Mutter, 100 Stück

Art-Nr.	Typ	Preis
M8 x 25 Schloss	M8 x 25	115,00



Kunststoff-Hutkappen

Kunststoff-Hutkappen
100 Stück/Paket für Sechskant-
Schraubenköpfe M6

Art-Nr.	Farbe	Preis
HK 1	rot	37,00
HK 2	gelb	37,00
HK 3	blau	37,00
HK 4	weiss	37,00
HK 5	schwarz	37,00



Lochung von Verkehrszeichen (auf Anfrage)

	Standardplan I Lochabstand 70 mm	Standardplan II Lochabstand 70 – 700 mm	Standardplan III für Rohrrahmen
SL 900			
ø 420			
ø 600			
600 x 600			
600 x 600			

Lochung von Verkehrszeichen (auf Anfrage)

	Standardplan I Lochabstand 70 mm	Standardplan II Lochabstand 70 – 700 mm	Standardplan III für Rohrrahmen
B 900			
200 x 1000 333 x 1000 600 x 900			
330 x 600 450 x 600			
900 x 600			
350 x 1250 350 x 1400 350 x 1500 350 x 1750 400 x 1500 400 x 1750 450 x 1500 450 x 1750			



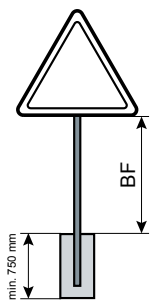

Artikel	Schildmaße (mm)	Bodenfreiheit (BF, mm)	∅ Standrohr (mm)	Standrohr Länge (mm)	Preis
E 01	SL 630	2250	60,3/2,0	3000	186,00
E 02	SL 900	2250	60,3/2,0	3000	191,00
E 03	SL 1260	2250	76,1/2,0	3000	198,00

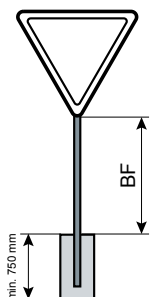

E 06	SL 630	2250	60,3/2,0	3000	186,00
E 07	SL 900	2250	60,3/2,0	3000	191,00
E 08	SL 1260	2250	76,1/2,0	3000	198,00

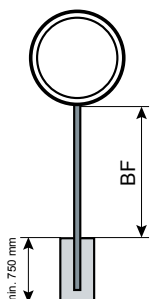

E 11	∅ 420	2250	60,3/2,0	3000	140,00
E 12	∅ 600	2250	60,3/2,0	3000	150,00
E 13	∅ 750	2250	60,3/2,0	3000	204,00
E 17	∅ 600	600	60,3/2,0	1350	150,00
E 18	∅ 750	600	60,3/2,0	1350	175,00

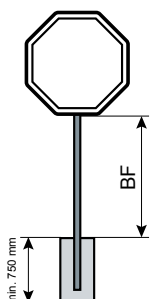

E 22	900 x 900	2250	76,1/2,0	3000	220,00
E 23	1050 x 1050	2250	76,1/2,9	3000	365,00

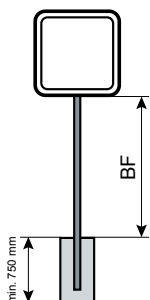

E 31	420 x 420	2250	60,3/2,0	3000	132,50
E 32	600 x 600	2250	60,3/2,0	3000	136,50
E 33	840 x 840	2250	76,1/2,0	3000	175,00
E 34	750 x 750	2250	76,1/2,0	3000	153,00
E 35	500 x 500	2250	60,3/2,0	3000	138,00
E 39	1000 x 1000	2250	76,1/2,9	3000	251,00

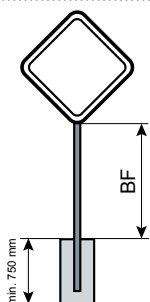

E 36	420 x 420	2250	60,3/2,0	3000	180,00
E 37	600 x 600	2250	60,3/2,0	3000	186,00
E 38	840 x 840	2250	76,1/2,0	3000	216,00

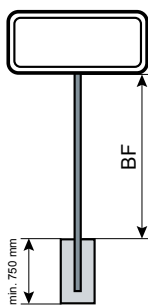

Artikel	Schildmaße (mm)	Bodenfreiheit (BF, mm)	∅ Standrohr (mm)	Standrohr Länge (mm)	Preis
E 41	200 x 750	2250	60,3/2,0	3000	126,50
E 42	200 x 1000	2250	60,3/2,0	3000	130,50
E 43	300 x 800	2250	60,3/2,0	3000	140,00
E 44	333 x 1000	2250	60,3/2,0	3000	140,00
E 45	333 x 1250	2250	60,3/2,0	3000	143,00
E 46	350 x 1050	2250	60,3/2,0	3000	138,00
E 47	420 x 630	2250	60,3/2,0	3000	130,00
E 48	600 x 900	2250	60,3/2,0	3000	161,00
E 48-2,9	600 x 900	2250	60,3/2,9	3000	193,00
E 49	840 x 1260	2250	76,1/2,9	3000	265,00
E 50	650 x 1000	2250	60,3/2,9	3000	235,00

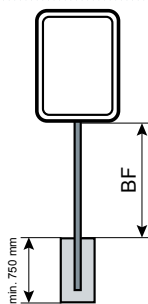

E 61	630 x 420	2250	60,3/2,0	3000	130,00
E 62	900 x 600	2250	60,3/2,0	3000	161,00
E 62-2,9	900 x 600	2250	60,3/2,9	3000	240,00
E 64	750 x 500	2250	60,3/2,0	3000	188,00
E 65	1000 x 650	2250	60,3/2,0	3000	275,00
E 67	750 x 500	600	60,3/2,0	1350	131,50

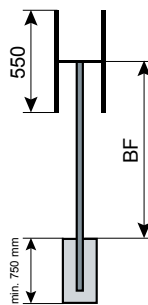

GP 1	500 x 500	1300	60,3/2,0	2000	100,00
HKST 60	500 x 500	1650	60,3/2,0	2300	140,00

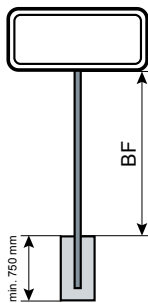

RR-KM 1	150 x 300	950	48,3/2,0	1700	120,00
RR-KM 2	220 x 400	950	48,3/2,0	1700	158,00
RR-KM 3	260 x 550	950	48,3/2,0	1700	168,00

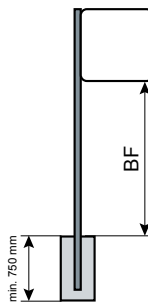

EF 1	420 x 420	2250	60,3/2,0	3000	175,00
EF 2	600 x 600	2250	60,3/2,0	3000	192,00
EF 3	750 x 750	2250	76,1/2,0	3000	255,00
EF 4	840 x 840	2250	76,1/2,0	3000	270,00

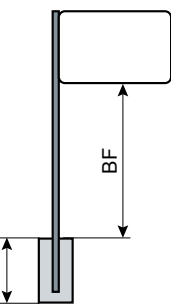

EF 5	420 x 630	2250	60,3/2,0	3000	185,00
EF 6	600 x 900	2250	60,3/2,9	3000	275,00

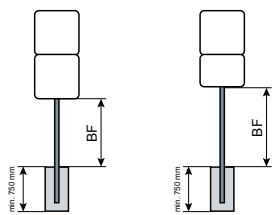

Artikel	Schildmaße (mm)	Bodenfreiheit (BF, mm)	∅ Standrohr (mm)	Standrohr Länge (mm)	Preis
ED 1	2 x 600 x 600	2250	76,1/2,0	3000	280,00
ED 2	600 x 600 + 330 x 600	2250	60,3/2,9	3000	265,00

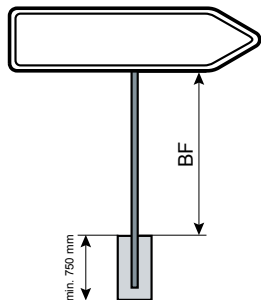

E 811	250 x 1000	2250	60,3/2,0	3000	162,00
E 820	333 x 1250	2250	60,3/2,0	3000	192,00
E 822	350 x 1250	2250	60,3/2,0	3000	179,00
E 829	350 x 1400	2250	60,3/2,0	3000	175,00
E 823	350 x 1500	2250	60,3/2,0	3000	270,00
E 824	350 x 1750	2250	60,3/2,9	3000	300,00
E 833	400 x 1500	2250	60,3/2,9	3000	338,00
E 834	400 x 1750	2250	60,3/2,9	3000	330,00
E 835	400 x 2000	2250	76,1/2,0	3000	345,00
E 843	450 x 1500	2250	76,1/2,0	3000	360,00
E 844	450 x 1750	2250	76,1/2,0	3000	375,00
E 845	450 x 2000	2250	76,1/2,0	3000	395,00
E 854	500 x 1750	2250	76,1/2,9	3000	436,00
E 855	500 x 2000	2250	76,1/2,9	3000	464,00

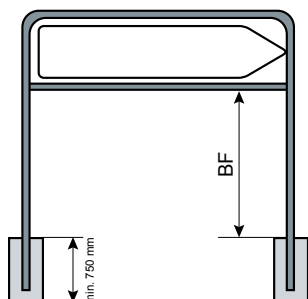

Z 811	250 x 1000	1000	48,3/2,0	1750	223,00
Z 74	333 x 1250	1000	48,3/2,0	1750	220,00
Z 822	350 x 1250	1000	48,3/2,0	1750	257,00
Z 829	350 x 1400	1000	48,3/2,0	1750	198,00
Z 823	350 x 1500	1000	48,3/2,0	1750	218,00
Z 824	350 x 1750	1000	48,3/2,0	1750	224,00
Z 833	400 x 1500	1000	48,3/2,0	1750	270,00
Z 834	400 x 1750	1000	48,3/2,0	1750	275,00
Z 835	400 x 2000	1000	48,3/2,0	1750	281,00
Z 843	450 x 1500	1000	48,3/2,0	1750	310,00
Z 844	450 x 1750	1000	48,3/2,0	1750	320,00
Z 845	450 x 2000	1000	48,3/2,0	1750	330,00
Z 854	500 x 1750	1000	48,3/2,0	1750	317,00
Z 76	500 x 2000	1000	48,3/2,0	1750	227,00
Z 77	500 x 2500	1000	60,3/2,0	1750	367,00
Z 875	600 x 2000	1000	60,3/2,0	1750	440,00
Z 877	600 x 2500	1000	60,3/2,0	1750	600,00

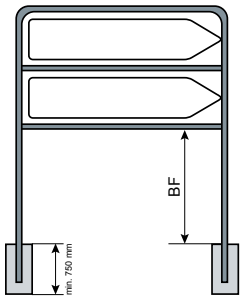

Artikel	Schildmaße (mm)	Bodenfreiheit (BF, mm)	∅ Standrohr (mm)	Standrohr Länge (mm)	Preis
Z 921	2 x 333 x 1250	1000	48,3/2,0	1750	310,00
Z 922	2 x 350 x 1250	1000	48,3/2,0	1750	330,00
Z 929	2 x 350 x 1400	1000	48,3/2,0	1750	280,00
Z 923	2 x 350 x 1500	1000	48,3/2,0	1750	342,00
Z 924	2 x 350 x 1750	1000	60,3/2,0	1750	410,00
Z 933	2 x 400 x 1500	1000	60,3/2,0	1750	415,00
Z 934	2 x 400 x 1750	1000	60,3/2,0	1750	415,00
Z 935	2 x 400 x 2000	1000	60,3/2,0	1750	434,00
Z 943	2 x 450 x 1500	1000	60,3/2,0	1750	415,00
Z 944	2 x 450 x 1750	1000	60,3/2,0	1750	440,00
Z 945	2 x 450 x 2000	1000	60,3/2,9	1750	615,00
Z 954	2 x 500 x 1750	1000	60,3/2,9	1750	606,00
Z 955	2 x 500 x 2000	1000	60,3/2,9	1750	629,00
Z 975	2 x 600 x 2000	1000	76,1/2,9	1750	715,00

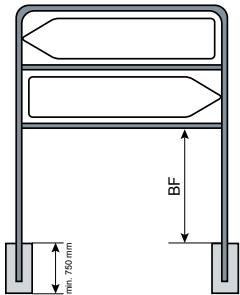

Z 71	250 x 1500	1000	48,3/2,0	1750	254,00
Z 72	250 x 2000	1000	48,3/2,0	1750	203,00
Z 73	250 x 2500	1000	48,3/2,0	1750	215,00
Z 74	333 x 1250	1000	48,3/2,0	1750	210,00
Z 75	500 x 1500	1000	48,3/2,0	1750	245,00
Z 76	500 x 2000	1000	48,3/2,0	1750	280,00
Z 77	500 x 2500	1000	60,3/2,0	1750	349,00
Z 78	600 x 900	1000	48,3/2,0	1750	227,00
Z 781	650 x 1000	1000	48,3/2,0	1750	281,00
Z 79	840 x 1260	1000	60,3/2,0	1750	343,00

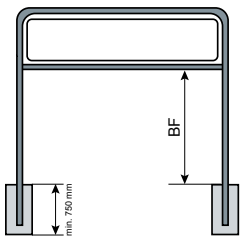

Z 01	600 x 600	1000	48,3/2,0	1750	270,00
Z 02	750 x 750	1000	48,3/2,0	1750	420,00
Z 03	840 x 840	1000	48,3/2,0	1750	330,00

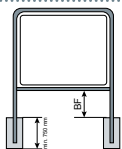

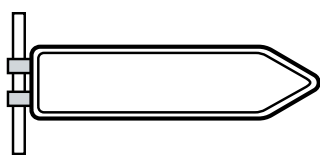

Artikel	Schildmaße (mm)	∅ Schellen (mm)	Preis
FS 811/1	250 x 1000	60	142,00
FS 811/3	250 x 1000	76	143,00
FS 811/5	250 x 1000	88,9	148,00
FS 811/6	250 x 1000	108	150,00
FS 820/1	333 x 1250	60	145,00
FS 820/3	333 x 1250	76	147,00
FS 820/5	333 x 1250	88,9	150,00
FS 820/6	333 x 1250	108	155,00
FS 822/1	350 x 1250	60	176,00
FS 822/3	350 x 1250	76	207,00
FS 822/5	350 x 1250	88,9	212,00
FS 822/6	350 x 1250	108	219,00
FS 829/1	350 x 1400	60	159,00
FS 829/3	350 x 1400	76	160,00
FS 829/5	350 x 1400	88,9	162,00
FS 829/6	350 x 1400	108	165,00
FS 823/1	350 x 1500	60	209,00
FS 823/3	350 x 1500	76	215,00
FS 823/5	350 x 1500	88,9	220,00
FS 823/6	350 x 1500	108	228,00
FS 833/1	400 x 1500	60	257,00
FS 833/3	400 x 1500	76	263,00
FS 833/5	400 x 1500	88,9	270,00
FS 833/6	400 x 1500	108	277,00

Artikel	Schildmaße (mm)	Bezeichnung	Preis
FB 811	250 x 1000	Bandschellen	142,00
FB 820	333 x 1250	Bandschellen	145,00
FB 822	350 x 1250	Bandschellen	158,00
FB 829	350 x 1400	Bandschellen	159,00
FB 823	350 x 1500	Bandschellen	164,00
FB 833	400 x 1500	Bandschellen	192,00

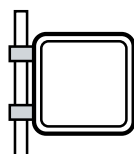

FS 31/1	420 x 420	60	99,50
FS 31/3	420 x 420	76	113,00
FS 31/5	420 x 420	88,9	118,00
FS 31/6	420 x 420	108	120,00
FS 32/1	600 x 600	60	105,00
FS 32/3	600 x 600	76	113,00
FS 32/5	600 x 600	88,9	118,00
FS 32/6	600 x 600	108	135,00
FS 33/1	840 x 840	60	118,00
FS 33/3	840 x 840	76	124,00
FS 33/5	840 x 840	88,9	132,00
FS 33/6	840 x 840	108	141,00
FS 34/1	750 x 750	60	114,00
FS 34/3	750 x 750	76	119,00
FS 34/5	750 x 750	88,9	125,00
FS 34/6	750 x 750	108	135,00

FB 31	420 x 420	Bandschellen	110,00
FB 32	600 x 600	Bandschellen	114,00
FB 33	840 x 840	Bandschellen	120,00
FB 34	750 x 750	Bandschellen	114,00

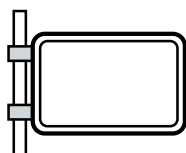

FS 47/1	420 x 630	60	114,00
FS 47/3	420 x 630	76	121,00
FS 47/5	420 x 630	88,9	141,00
FS 47/6	420 x 630	108	151,00
FS 48/1	600 x 900	60	127,00
FS 48/3	600 x 900	76	132,00
FS 48/5	600 x 900	88,9	161,00
FS 48/6	600 x 900	108	191,00

FB 47	420 x 630	Bandschellen	118,00
FB 48	600 x 900	Bandschellen	135,00

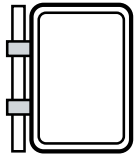

Artikel	Schildmaße (mm)	Ø Schellen (mm)	Preis	Artikel	Schildmaße (mm)	Bezeichnung	Preis
FS 61/1	630 x 420	60	114,00	FB 61	630 x 420	Bandschellen	118,00
FS 61/3	630 x 420	76	121,00				
FS 61/5	630 x 420	88,9	141,00				
FS 61/6	630 x 420	108	151,00				
FS 62/1	900 x 600	60	127,00	FB 62	900 x 600	Bandschellen	135,00
FS 62/3	900 x 600	76	132,00				
FS 62/5	900 x 600	88,9	161,00				
FS 62/6	900 x 600	108	191,00				
FS 63/1	750 x 500	60	122,00	FB 63	750 x 500	Bandschellen	128,00
FS 63/3	750 x 500	76	126,00				
FS 63/5	750 x 500	88,9	145,00				
FS 63/6	750 x 500	108	170,00				

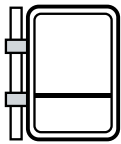

FSD 1	600 x 600 u. 330 x 600	60	143,00	FBD	600 x 600 u. 330 x 600	Bandschellen	149,00
FSD 3	600 x 600 u. 330 x 600	76	149,00				
FSD 5	600 x 600 u. 330 x 600	88,9	152,00				
FSD 6	600 x 600 u. 330 x 600	108	161,00				

Sonderrohrrahmen, feuerverzinkt,
ohne Schilder (Schilder siehe Seite 52.)

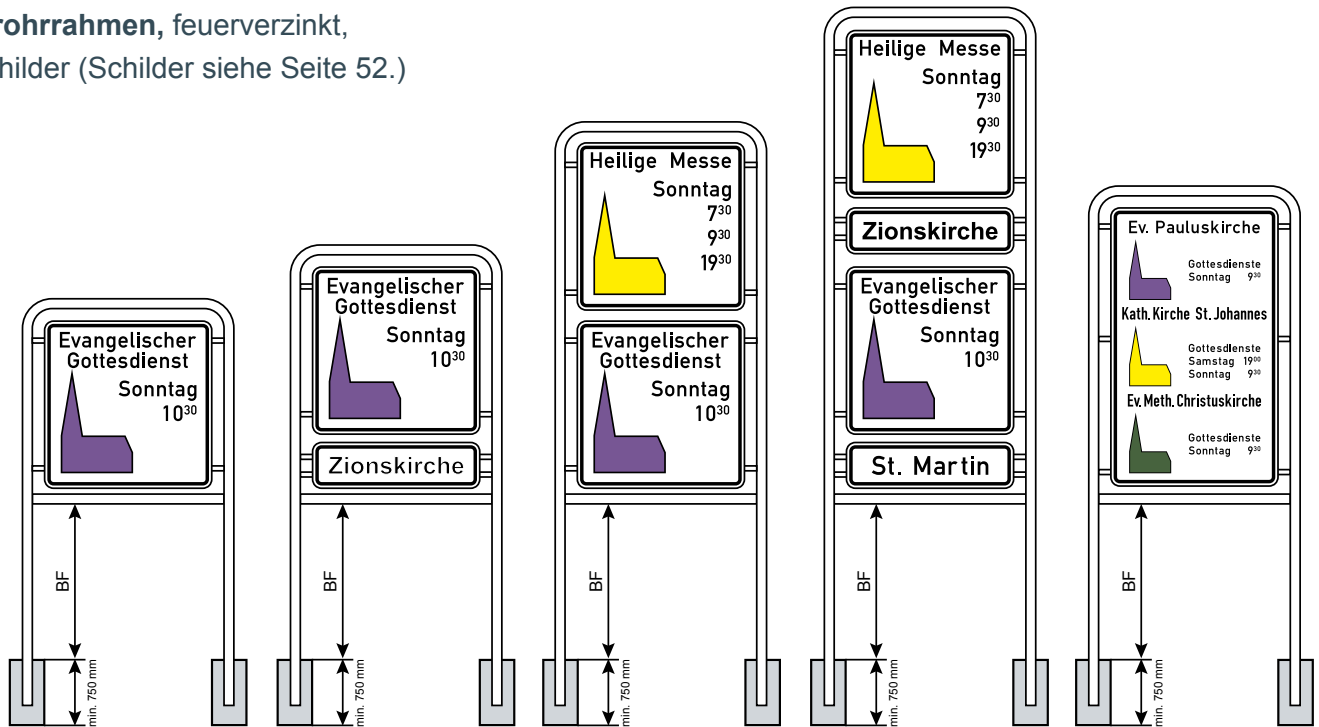

Best-Nr.	GR 1	GR 2	GR 3	GR 4	GR 5
Schildmaße (mm)	750 x 750	750 x 750 + 200 x 750	2 x 750 x 750	2 x 750 x 750 2 x 200 x 750	1250 x 750
Ø (mm)	48,3/2,0	48,3/2,0	48,3/2,0	60,2/2,0	48,3/2,0
Bodenfreiheit (BF, mm)	1000	1000	1000	1000	1000
Preis	312,00	362,00	425,00	528,00	386,00

Rohrrahmenpreise ohne Schilder!

Ausleger-Rohrposten ohne Rohrschellen
feuerverzinkt

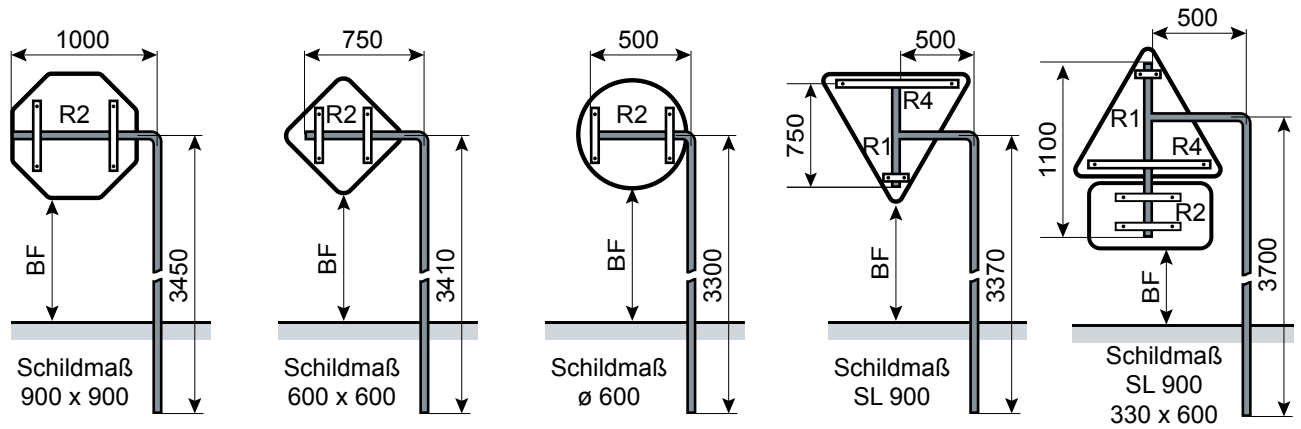

Best-Nr.	AL 1	AL 2	AL 3	AL 4	AL 5
Ausleger (mm)	1000	750	500	500	500
ø (mm)	60,3/2,9	60,3/2,9	60,3/2,9	60,3/2,9	60,3/2,9
Bodenfreiheit (BF, mm)	2250	2250	2250	2250	2250
Preis	195,00	155,00	145,00	176,00	275,00

Wandhalterung 90°

zur Anbringung von Verkehrszeichen, aus Flachstahl, feuerverzinkt, Bohrung lt. IVZ-Norm

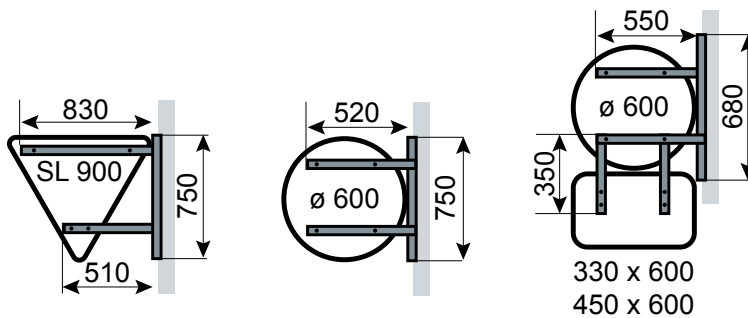

Best-Nr.	HA 1	HA 2	HA 3
Material (mm)	30 x 5	40 x 5	40 x 5
Preis	75,00	70,00	98,00

Ampelmastaufsetzer

für ø 108 mm, feuerverzinkt, mit 3 aufgeschweißten Muttern M8

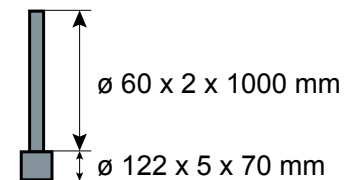

Best-Nr.	AA1
Material (mm)	andere Abmessungen auf Anfrage
Preis	328,00